

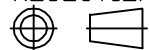

7	N35 Magnet	NI	1
6	GPS Antenna		1
5	Hot Shrink Tube	PE BLACK	1
4	3M Glue	VHB	1
3	SMA CONNECTOR	GOLD	1
2	RG174 CABLE	PVC BLACK	1
1	ANTENNA COVE	ABS BLACK	1
	Description	Material	Q'ty

Electrical Properties	
Frequency Range	1575.42MHZ
Impedance	50 Ω
V.S.W.R.	≤2.0
Radiation	Omni
Gain	25±3DBi
Polarization	Vertical
Mechanical Properties	
Whip	ABS
Standard Connector	SMA MALE
Waterprooflevel	IP65
Operating Temp	-φ40°~+80°

THIRD ANGLE PROJECTION  Tolerance .X ±0.1 .XX ±0.05 .x ±1°	DRAWN BY	HZH	MATERIAL:		PART NO:	P46X. S0. 1. 333
	CHECKED BY		FINISH:	BLACK	TITLE:	GPS Antenna
	APPROVED BY	King	UNIT:	mm	 <b>RUNSHUN</b> Dongguan RunShun Technology Co., Ltd	
	DATE:	20. 8. 21	SCALE:	1/1		

产品照片  
Product Photos



## Passive mode

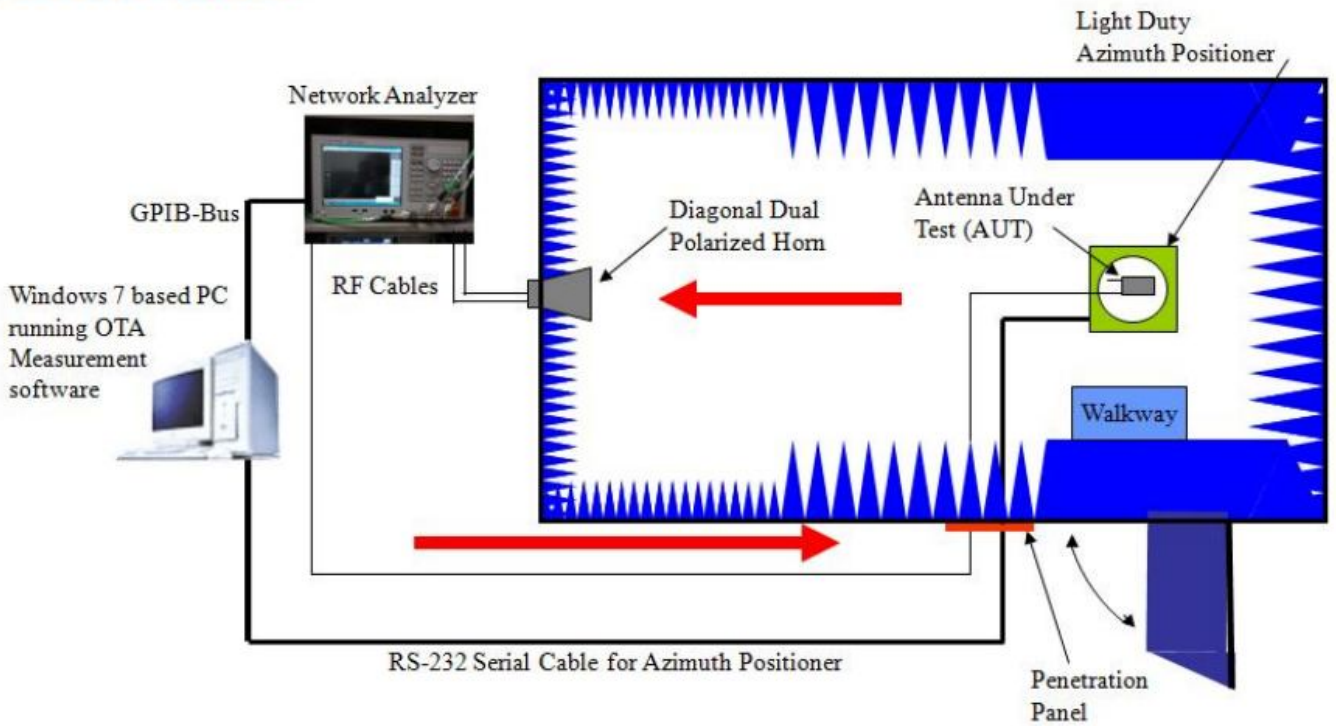

### TEST INSTRUMENT :

1. AGILENT E5071C NETWORK ANALYZER
2. 3D OTA Chamber(WanShih)

### Anechoic Chamber External Dimensions

(L x W x H): 8m x 4m x 4m

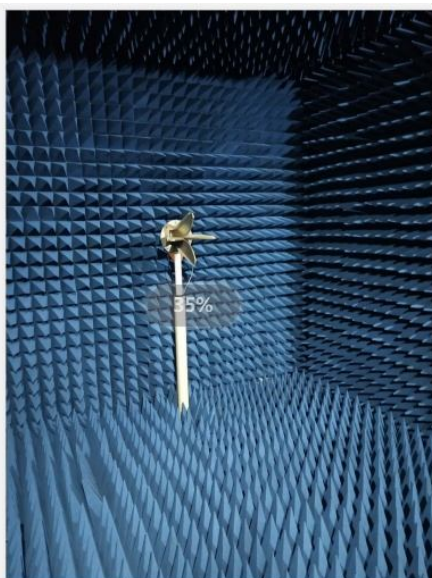

## Ceramics ANT

Frequency Range	1575.42 ± 3 MHz
Resistance	50Ω
Polarization	R.H.C.P
Axial ratio	3.0dB typical
Output V.S.W.R	≤2.0
Peak gain	3dBi

## LNA

Gain	25 ± 3 dB
In-band flatness	0.8 dB at 3V
Operating Voltage	3~5V
Current	DC=12mA at 3V

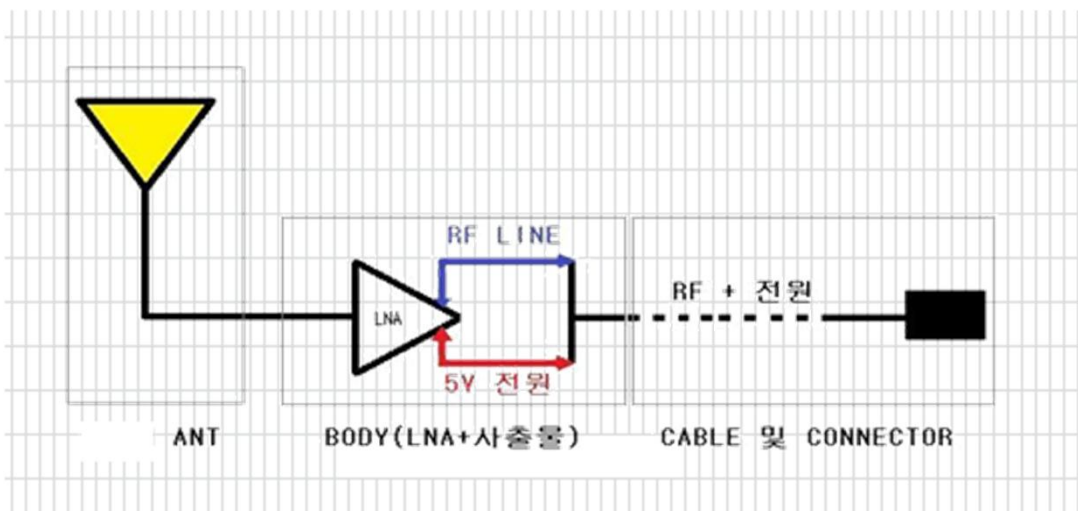

# GAIN

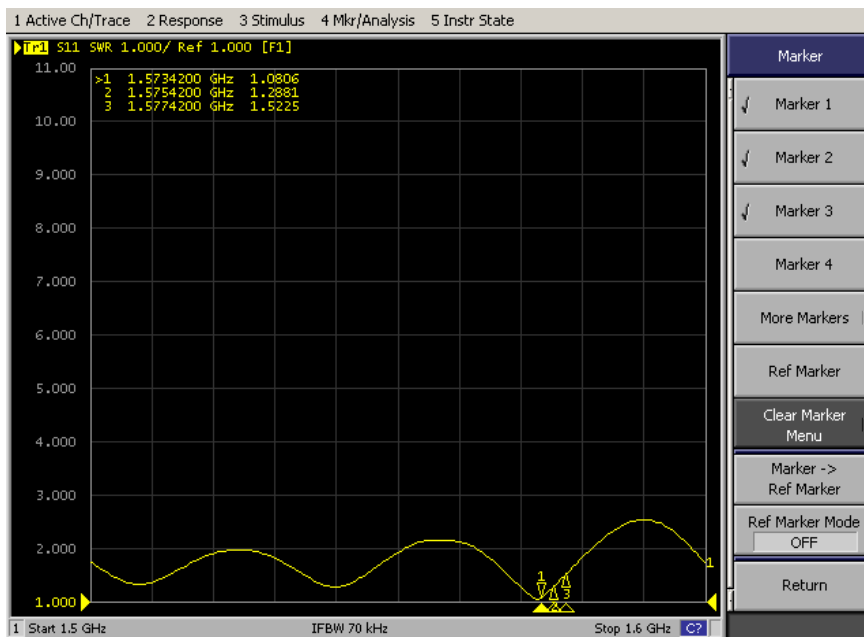
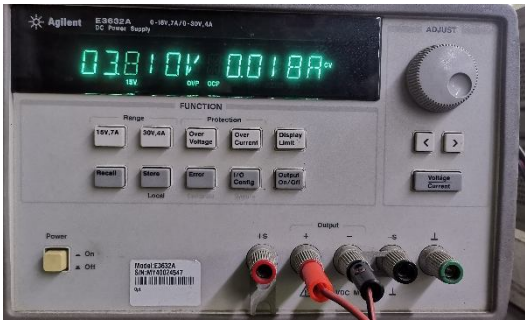

VSWR

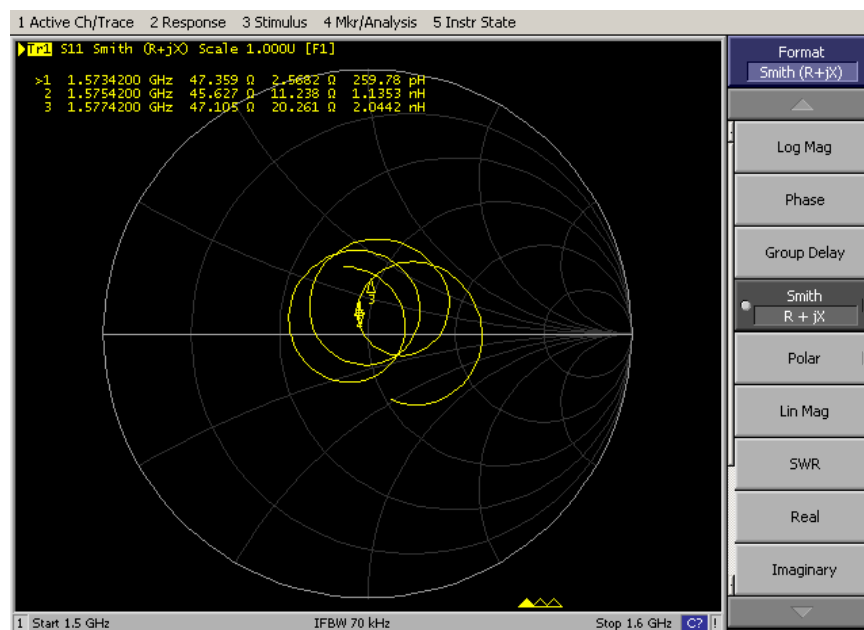

Smith Chart



## PCB



PCB TOP

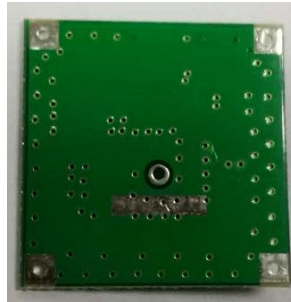

BOTTOM

## Part list

### Part list

Parts No.	Parts Name	Spec.	제조사	비 고
C1,C2	Condensor	20pF	FENG HUA	
C3 C4 C6	Condensor	0.001uF	FENG HUA	
C5 C7	Condensor	0.1uF	FENG HUA	
R1 R2	Resistanse	150Ω	HOU SHENG	
R3 R4	Resistanse	15KΩ	HOU SHENG	
Q1 Q2	LNA	BFG425W	NEC	
Y1	Saw Filter	DFC1575P010	JIA KANG	